

X7CQAP-FRO-660-V

+/- 45° Polarization, (1) 698-896MHz & (2) 1695-2180 MHz Antenna, 72" Length, Fast Roll Off 60° Horizontal Pattern, Variable E-Tilt

- Fast Roll Off (FRO) improves Intra and Inter-cell SINR
- Separate housing and reflector construction optimizes RF performance while maximizing mechanical strength
- Good Passive Intermodulation (PIM) performance reduces harmful interference
- Independent tilt per array
- Suitable for LTE/CDMA/UMTS/GSM
- AISG 2.0 RET Control

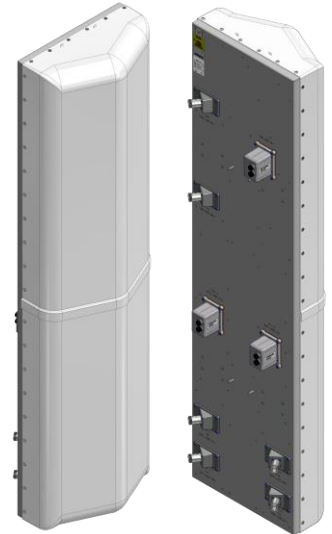

ELECTRICAL SPECIFICATIONS

Frequency Band, MHz	698-824	824-896	1695-1850	1850-1990	1990-2180
Horizontal Beam Width, 3dB points	60°	57°	56°	57°	58°
Gain, dBi	15.6	15.9	17.7	17.6	17.8
Vertical Beam Width, 3dB points	13.0°	11.4°	5.7°	5.4°	5.3°
Upper Side Lobe Suppression, Typical, dB	<-18	<-18	<-18	<-18	<-18
Front-to-Back at 180°, dB	> 30		> 30		
Polarization	+/-45°		2x +/-45°		
Electrical Downtilt (See Order Information)	0°-10°/ 4°-14°		0°- 11°		
VSWR/Return Loss, dB, Maximum	1.5:1/14.0		1.5:1/14.0		
Isolation Between Ports, dB, Minimum	>26		>26		
Intermodulation (2x20w), IM3, dBc, Maximum	-153		-153		
Impedance, ohms	50		50		
Maximum Power Per Connector, CW (w)	500		250		

MECHANICAL SPECIFICATIONS

Dimensions, Length/Width/Depth	72.0/19.2 /10.2 in (1832/476/258mm)
Connector (Quantity) Type	(6 total: 2 low, 4 high band) 7-16 DIN Female
Connector Torque	220-265 lbf-in (25-30 N-m)
Connector Location	Back
Antenna Weight	50 lbs
Bracket Weight (not included in antenna weight)	13.2 lbs (5.99Kg)
Standard Bracket Kit	919011 (Included)
Mechanical Downtilt Range	0°-12°
Radome Material	High Strength Luran, UV Stabilized, ASTM D1925
Wind Survival	150 mph (241 km/h)
Front Wind Load @100mph	234 lbf (1039 N)
Equivalent Flat Plate @ 100mph	4.65 sq-ft (c=2) @100 mph

RET INFORMATION (RET motors included in VR0 & VR4 models)

Model	RET-200
Mounting Location	Back
Communication Standard	AISG 2.0
Control System	PCU-220



ORDER INFORMATION

MODEL	DESCRIPTION
X7CQAP-FRO-660-VR0	Remote motor adjust variable e-tilt (RET), EDT 0-10° low band and 0-11° high band
X7CQAP-FRO-660-VR4	Remote motor adjust variable e-tilt (RET), EDT 4-14° low band and 0-11° high band
919036	Optional Bracket Kit, 2-Point, 12deg D-tilt, For 4.5" OD Pole

OTHER ORDERING INFORMATION

MODEL	DESCRIPTION
992100-CA013-SC	AISG Jumper Cable, M/F, 1.3 meters

MECHANICAL VIEWS – X7CQAP-FRO-660-VR0

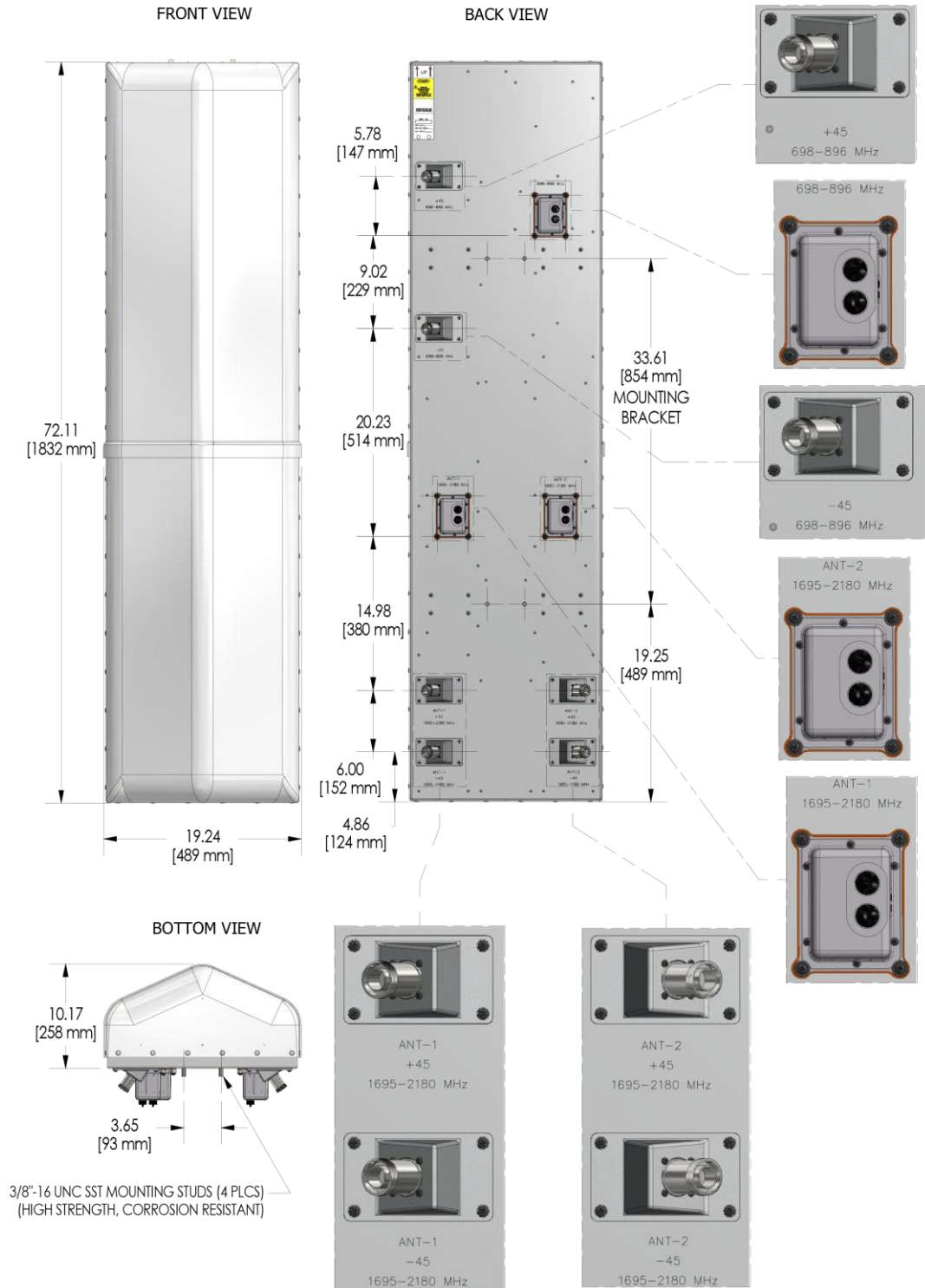

STANDARD BRACKET KIT – 919011

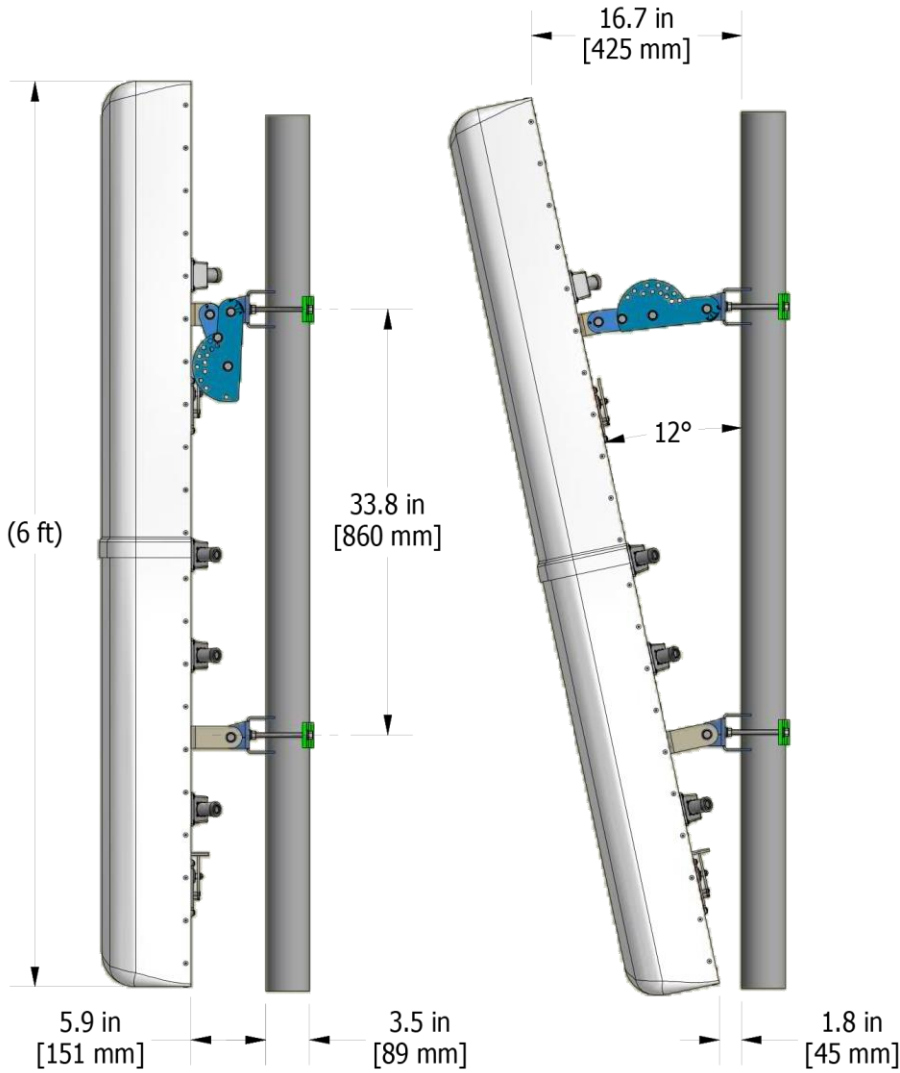

P/N: 919011 BRACKET KIT
2 POINT, 12 DEGREE DOWN TILT
SHOWN MOUNTED ON 3.5" O.D. POLE
3.5" O.D. MAX POLE SIZE

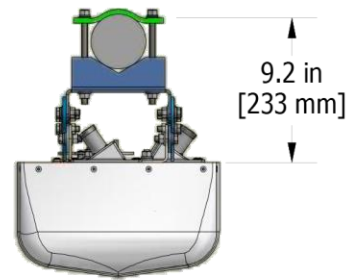

OPTIONAL BRACKET KIT – 919036

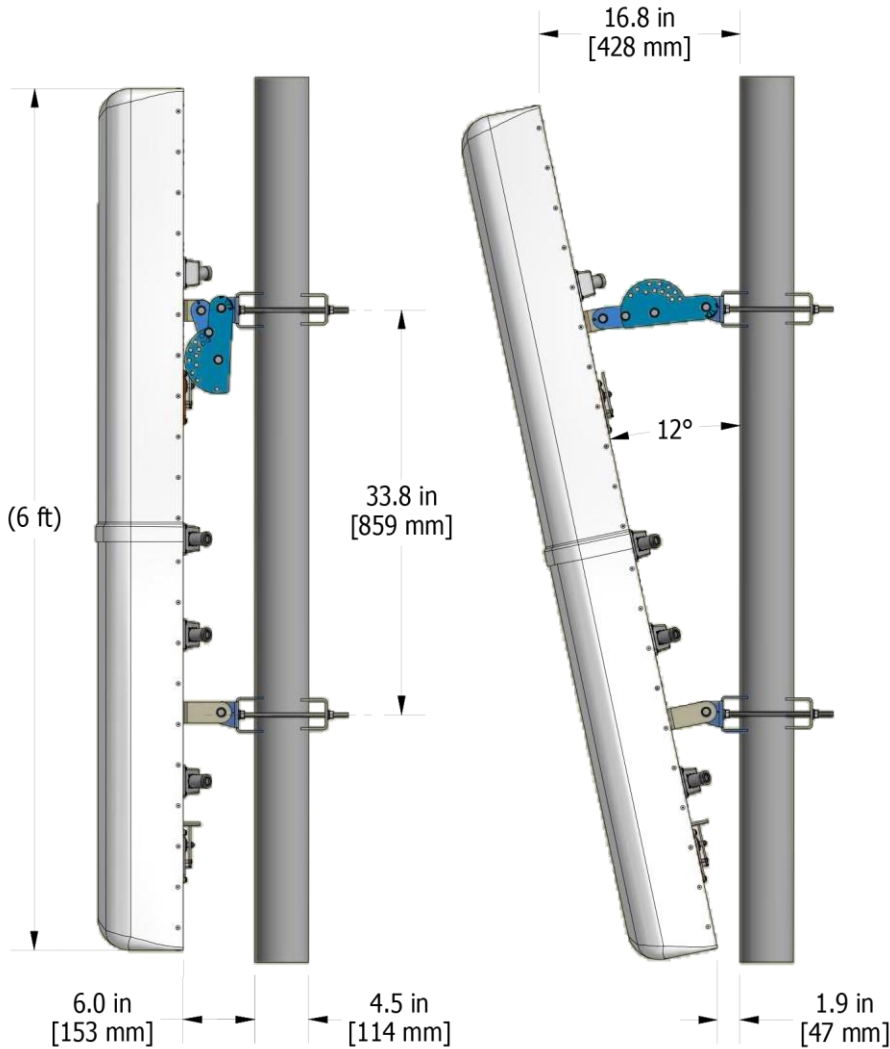

P/N: 919036 BRACKET KIT
2 POINT, 12 DEGREE DOWN TILT
SHOWN MOUNTED ON 4.5" O.D. POLE
4.5" O.D. MAX POLE SIZE

